

SOT-223 Plastic-Encapsulate Transistors

CZT122 TRANSISTOR (NPN)

FEATURES

- Complementary to CZT127
- Silicon Power Darlington Transistors
- Low speed switching and amplifier applications

SOT-223

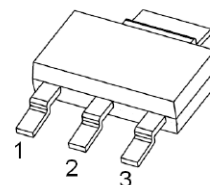

1. BASE
2. COLLECTOR
3. EMITTER

MAXIMUM RATINGS (T_a=25°C unless otherwise noted)

| Symbol | Parameter | Value | Unit |
|-----------------------------------|--|---------|------|
| V _{CB0} | Collector-Base Voltage | 100 | V |
| V _{CEO} | Collector-Emitter Voltage | 100 | V |
| V _{EBO} | Emitter-Base Voltage | 5 | V |
| I _C | Collector Current -Continuous | 5 | A |
| P _C | Collector Power Dissipation | 1 | W |
| T _J , T _{stg} | Operation Junction and Storage Temperature Range | -55~150 | °C |

ELECTRICAL CHARACTERISTICS (T_a=25°C unless otherwise specified)

| Parameter | Symbol | Test conditions | Min | Typ | Max | Unit |
|--------------------------------------|-----------------------|---|------|-----|-----|------|
| Collector-base breakdown voltage | V _{(BR)CBO} | I _C =1mA, I _E =0 | 100 | | | V |
| Collector-emitter breakdown voltage | V _{(BR)CEO} | I _C =30mA, I _B =0 | 100 | | | V |
| Collector cut-off current | I _{CBO} | V _{CB} =100V, I _E =0 | | | 200 | uA |
| Base cut-off current | I _{CEO} | V _{CE} =50V, I _B =0 | | | 500 | uA |
| Emitter cut-off current | I _{EBO} | V _{EB} =5V, I _C =0 | | | 2 | mA |
| DC current gain | h _{FE(1)} | V _{CE} =3V, I _C =0.5A | 1000 | | | |
| | h _{FE(2)} | V _{CE} =3V, I _C =3A | 1000 | | | |
| Collector-emitter saturation voltage | V _{CE(sat)1} | I _C =3A, I _B =12mA | | | 2 | V |
| | V _{CE(sat)2} | I _C =5A, I _B =20mA | | | 4 | V |
| Base-emitter voltage | V _{BE(on)} | V _{CE} =3V, I _C =3A | | | 2.5 | V |
| Transition frequency | f _T | V _{CE} =4V, I _C =3A, f=1MHz | 4 | | | MHz |
| Collector output capacitance | C _{ob} | V _{CB} =10V, I _E =0, f=1.0MHz | | | 200 | pF |

Typical Characteristics

CZT122

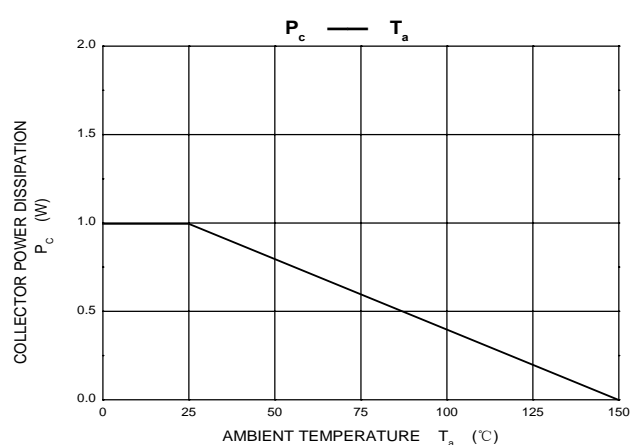
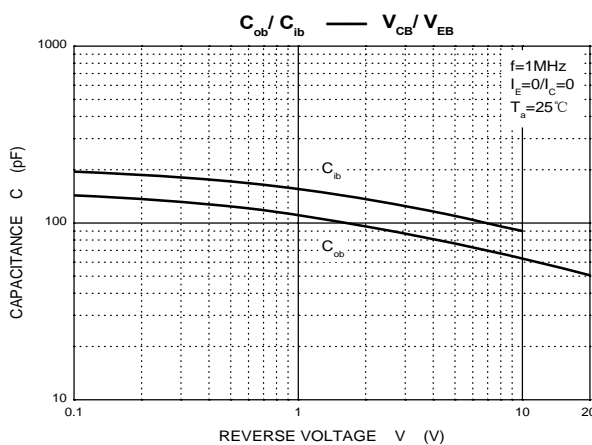
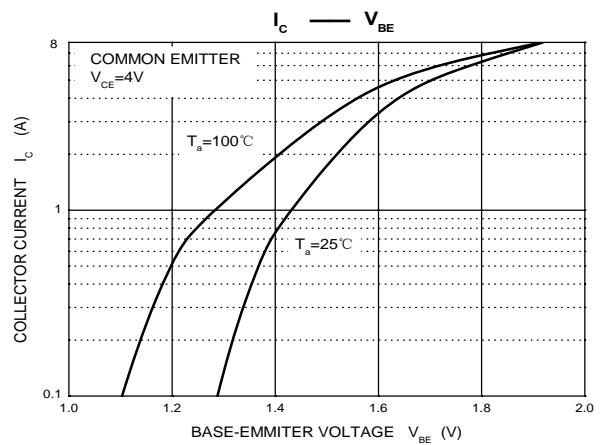
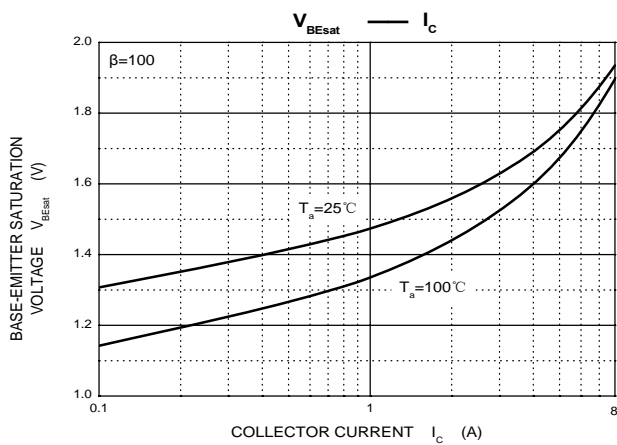
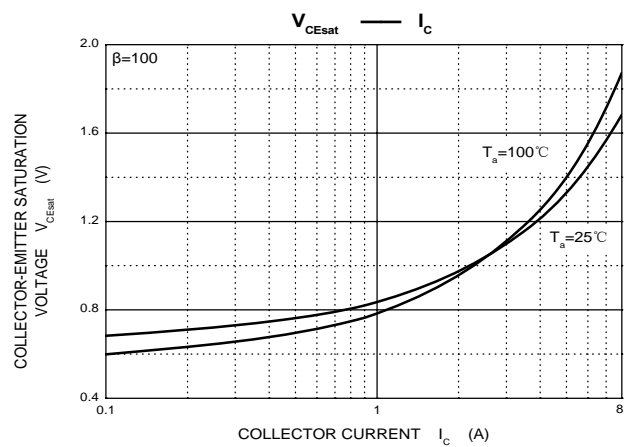
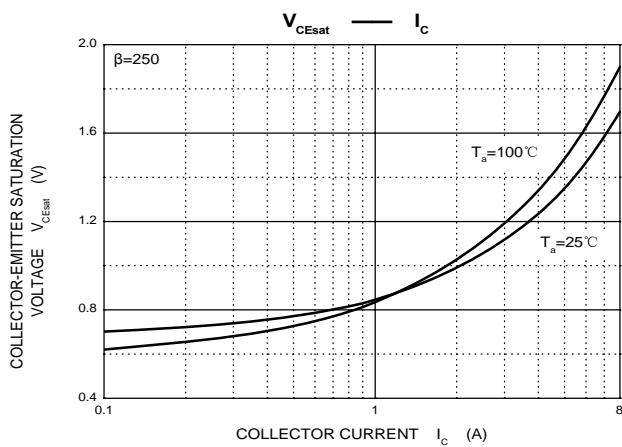
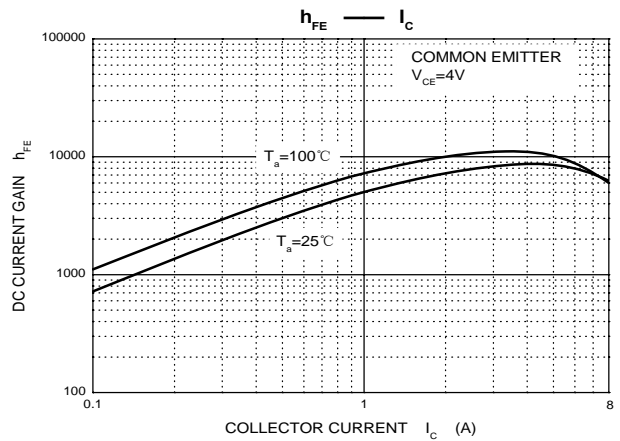
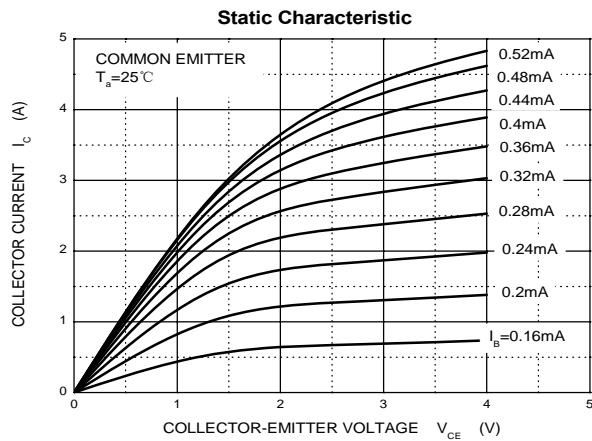

SOT-223 Package Outline Dimensions

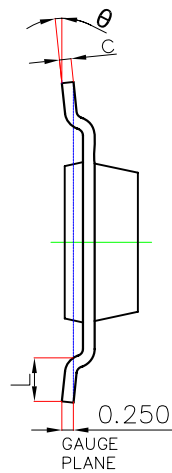
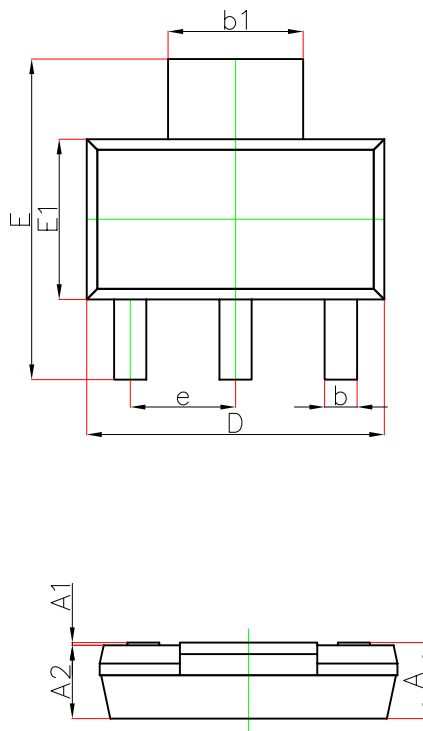

| Symbol | Dimensions In Millimeters | | Dimensions In Inches | |
|----------|---------------------------|-------|----------------------|-------|
| | Min. | Max. | Min. | Max. |
| A | — | 1.800 | — | 0.071 |
| A1 | 0.020 | 0.100 | 0.001 | 0.004 |
| A2 | 1.500 | 1.700 | 0.059 | 0.067 |
| b | 0.660 | 0.840 | 0.026 | 0.033 |
| b_1 | 2.900 | 3.100 | 0.114 | 0.122 |
| c | 0.230 | 0.350 | 0.009 | 0.014 |
| D | 6.300 | 6.700 | 0.248 | 0.264 |
| E | 6.700 | 7.300 | 0.264 | 0.287 |
| E1 | 3.300 | 3.700 | 0.130 | 0.146 |
| e | 2.300(BSC) | | 0.091(BSC) | |
| L | 0.750 | — | 0.030 | — |
| θ | 0° | 10° | 0° | 10° |

SOT-223 Suggested Pad Layout

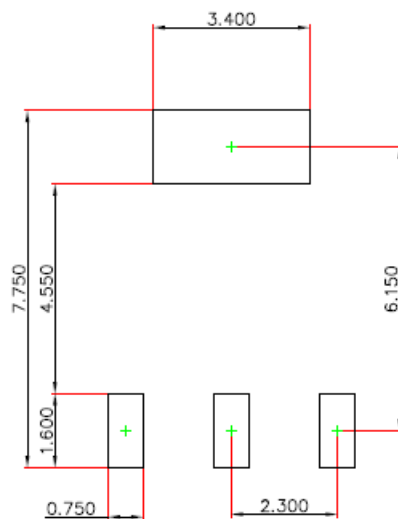

Note:

1. Controlling dimension: in millimeters.
2. General tolerance: ± 0.050 mm.
3. The pad layout is for reference purposes only.

NOTICE

JSCJ reserves the right to make modifications, enhancements, improvements, corrections or other changes without further notice to any product herein. JSCJ does not assume any liability arising out of the application or use of any product described herein.

SOT-223 Tape and Reel

SOT-223 Embossed Carrier Tape



Packaging Description:

SOT-223 parts are shipped in tape. The carrier tape is made from a dissipative (carbon filled) polycarbonate resin. The cover tape is a multilayer film (Heat Activated Adhesive in nature) primarily composed of polyester film, adhesive layer, sealant, and anti-static sprayed agent. These reeled parts in standard option are shipped with 2,500 units per 13" or 33.0cm diameter reel. The reels are clear in color and is made of polystyrene plastic (anti-static coated).

| Dimensions are in millimeter | | | | | | | | | | |
|------------------------------|-------|-------|------|-------|------|------|------|------|------|-------|
| Pkg type | A | B | C | d | E | F | P0 | P | P1 | W |
| SOT-223 | 6.765 | 7.335 | 1.88 | Ø1.50 | 1.75 | 5.50 | 4.00 | 8.00 | 2.00 | 12.00 |

SOT-223 Tape Leader and Trailer

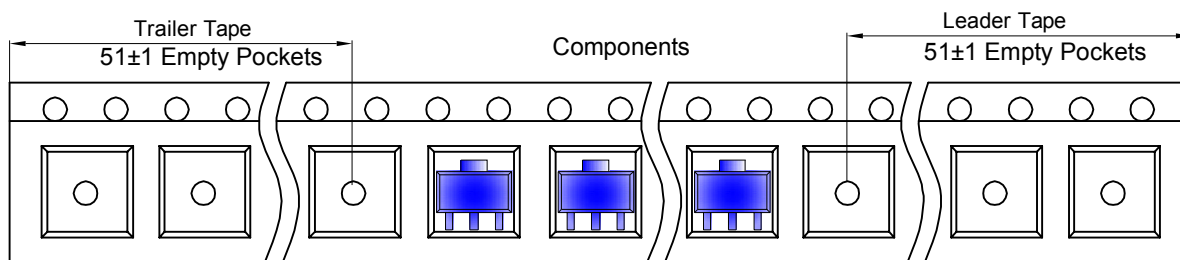

SOT-223 Reel

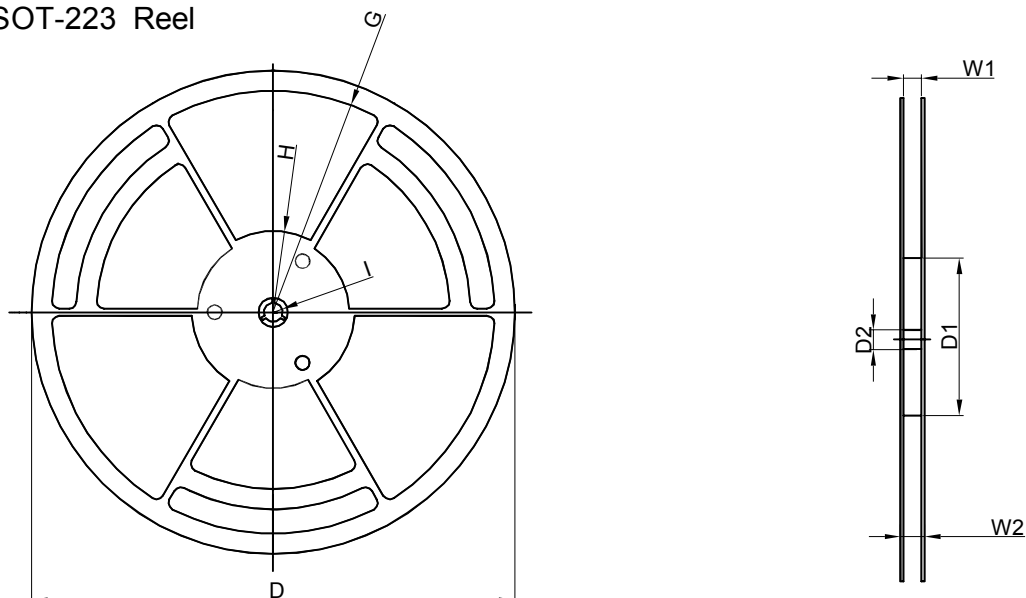

| Dimensions are in millimeter | | | | | | | | |
|------------------------------|---------|--------|-------|---------|--------|-------|-------|-------|
| Reel Option | D | D1 | D2 | G | H | I | W1 | W2 |
| 13" Dia | Ø330.00 | 100.00 | 13.00 | R151.00 | R56.00 | R6.50 | 12.40 | 17.60 |

| REEL | Reel Size | Box | Box Size(mm) | Carton | Carton Size(mm) | G.W.(kg) |
|-----------|-----------|-----------|--------------|------------|-----------------|----------|
| 2,500 pcs | 13 inch | 2,500 pcs | 336×336×48 | 20,000 pcs | 445×355×365 | |